

1964'den bugüne..

YAKAN AYDINLATMA®

Dış Mekan Dekoratif Aydınlatma Mamülleri İmalat ve Ticaret
Best Globe®



PAYS THE COST YOU BACK
IN ABOUT 2 YEARS



Monocrystalline
Panel



6-8 Hours of
Sunbathing Time



Lighting Time:
20-22 Hours with
Sensor

Y.A.127040

100W-150W SOLAR POWERED
(PHOTOVOLTAIC) LED LIGHTING

Let the Sun Pay Your Bills

Solar lighting systems are very beneficial to users' budgets and our environment. Solar lighting has a wide range of uses. In order to reduce electricity costs and have a sustainable green environment, we have developed our professional solar lighting products.



Long-Life LifePO4 Battery
Minimum 5 Years Life
Expectancy



100W-150W
Power Equivalent

R&D and Tests

We've been working on developing our solar LED lights for 7 years. It has a 5-year successful operation and sales history and has been tested more than 2,000 times.

Sensor Mode

The light intensity in this mode is such that the person can navigate comfortably by bicycle. In addition, sensor mode illuminates continuously.

Full Performance Mode

With the light intensity in this mode, the person can easily do activities such as can have meals, can read a book, etc.

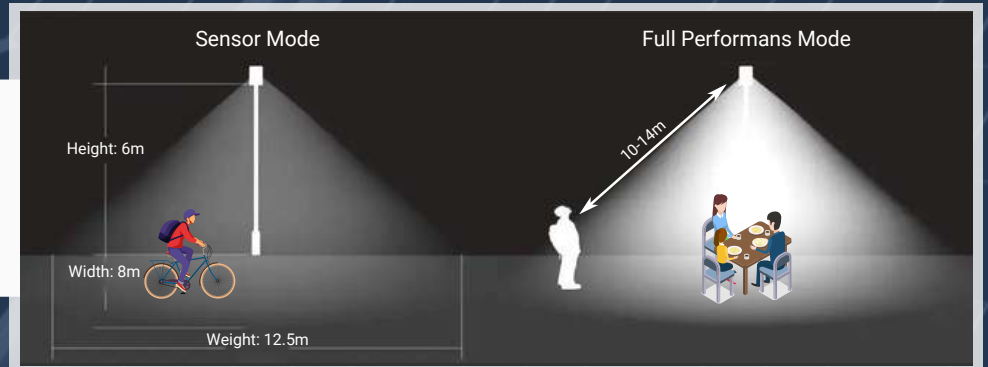

It is IP66-certified
waterproof and
dustproof.



2 Year Warranty
(Protection Against
Manufacturing Flaws)



Turkish Patent Design
and YKAN Green Power
Trademark
Registration

YAKAN AYDINLATMA®

YKAN®
green power
JOHAR ENERGY

best globe®



www.yakanaydinlatma.com



info@yakanaydinlatma.com.tr



+90 212 243 30 08

YKN GREEN POWER

Features of the Y.A.127040 100w-150w Solar-Powered (Photovoltaic) Led Lighting



IP66 WATERPROOF

YKN Green Power Photovoltaic Solar Lighting is fully protected against dust and pressurized water. IP66 certified.

PANEL

Monocrystalline

This panel more efficient as it consists of a single crystal structure.

The panel structure is suitable for 360° rotation and 0°-55° angle adjustments.

(Thus, it can be easily adjusted according to the sun's exposure angle)

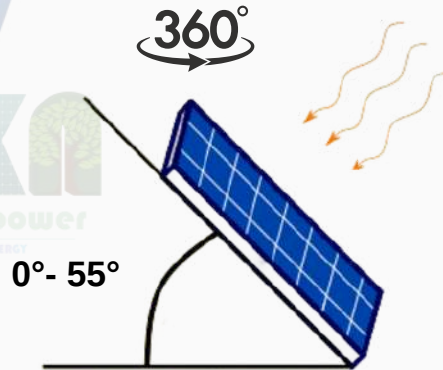

BODY MATERIAL

The Luminaire body is made of outdoor-compatible **IP66 aluminum**. (The product body, steel parts, and connection bolts are stainless)



Cable and PV Junction Box

The product cable system is suitable for outdoor conditions and it can be safely dismantled and mounted. There is a PV junction box with **IP67**.



Motion Sensor and Button



IP66 waterproof ON / OFF button with high current protection

The button must be pressed once at the first startup.

It can be programmed according to places of use.

Active and passive features of sensor can easily be programmed as per operating percentage (optional) as; sensor enabled (active) or sensor disabled (passive) operation.

Suitable for operation in -20°C to $+60^{\circ}\text{C}$ temperature conditions
(The Charge Controller can charge up to 0°C and discharge down to -20°C)

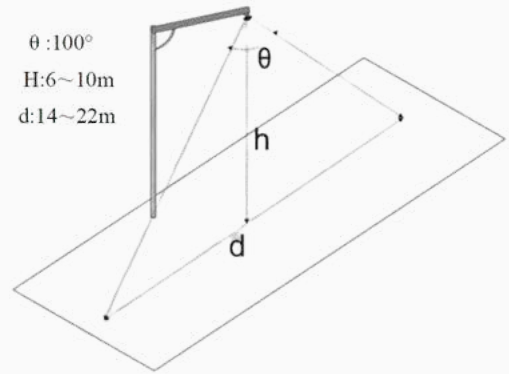

LiFePO4 Battery

It is considered the safest type of battery with the **current balancer BMS circuit system** because it does not cause problems such as heating, burning, etc. in extreme conditions. It has beneficial features such as enhanced power output, faster charging, reduced weight and **minimum 5 years** life expectancy.

In addition, LiFePO4 batteries are not harmful to the environment.

(Lead-free, certified)



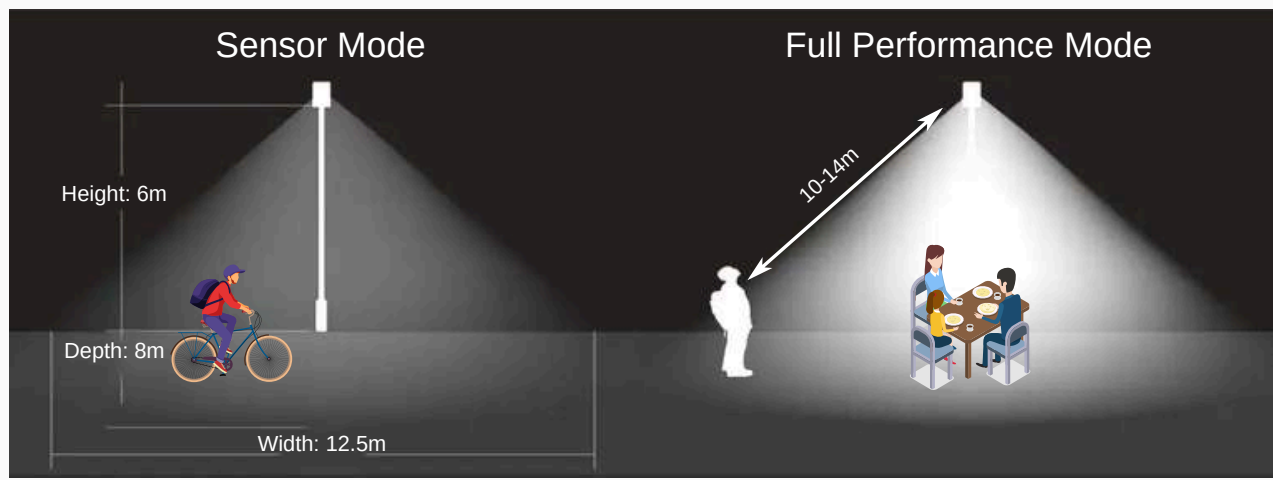

Y.A.127040 100w-150w Photovoltaic (Solar) Led Lighting



Our YKN Green Power photovoltaic solar product has an **IP66 waterproof** feature. During the installation of our solar product with a weight of **19.3 kg** and a **60-watt monocrystalline panel**, the cable connections with the IP67 feature included in the product should be made. Afterwards, the panel direction of our solar product should be adjusted at an angle of **40° and turned south**.

The first start-up of the product starts with pressing the on-off button on the front. There is no need for the user to intervene again.



The professional **LifePO4 battery**, which can be used for a long time (*minimum 5 years life expectancy*), is protected by the **balanced BMS circuit system** against overcharge and overdischarge situations. With this feature, our LifePO4 battery will work longer than other types of batteries. The batteries in the product have a 2-year manufacturer's warranty. LifePO4 batteries are safer than other types of batteries and are not harmful to the environment. It also has a **lead-free certificate**.



The product will **lights continuously for 12 hours** if the normal programming created after **6-8 hours of sunbathing** on the first day is followed.

It will provide active light with 50% of the product's working capacity in sensed mode. (*easily walking, riding a bicycle, etc.*). If the solar product used at 3m-6m height, it has a motion sensor that activates when something moves near it between **Ø10m - Ø14m, increasing its operating capacity from 50% to 100%**. (*comfortably have meals, can read a book, etc.*).



When Y.A.127040, a 100-150 watt photovoltaic solar product, is used at a height of 3 to 6 meters, **It will dominate an area of approximately 100 m2 (width: 12.5 m x length: 8 m) with a light intensity of 15-25 lux, with 220 lm/w LEDs that are special for the solar system, and with high light transmittance and high efficiency lenses.**

The solar product, with an aluminum body and is IP66 waterproof, will work successfully in outdoor temperature conditions of -20°C to +60°C.

According to our field tests,

When the luminous intensity of a 100-150 watt incandescent lamp falling on the ground is measured at a height of 3 meters, it is seen that the lamp light is 15-25 lux.

Accordingly, the Y.A.127040 100w-150w Solar Powered (Photovoltaic Solar) Led Lighting product is equalized to 15-25 lux with 6500K leds and solar lenses. It has an equivalent energy output of 100-150 watts.

According to general tests, LED lamps are declared to be **x10 more efficient** than incandescent bulbs. In addition, it is stated that LED luminaires **have a longer life** (e.g., 60,000 hours) than incandescent lamps.



In cases where it is determined that the device has been opened or repaired other than by authorized services, it is out of warranty.

The device is covered by a 2-year manufacturer's warranty.

 **YAKAN AYDINLATMA**

3



www.yakanaydinlatma.com



info@yakanaydinlatma.com.tr



+90 212 243 30 08

Y.A.127040 100w-150w Solar-Powered (Photovoltaic) Led Lighting User Guide

Important warning:

! After the solar system receives 6-8 hours of regular sunlight for the first 3 days, it will start to work according to the characteristics specified in the technical table.

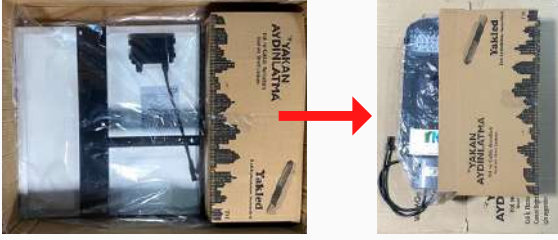

BOX CONTENTS

- Solar panel,
- Solar Panel PV junction box (IP67),
- Solar special cable (IP66),
- Aluminum solar body, solar special led and special lens (IP66),
- Solar charge control (IP68),
- Lithium LifePO4 battery,
- On/off switch with high current protection (IP67),
- Stainless bolts

1



Step 1: The solar-led luminaire is mounted to the pole with the stainless screws and nuts shown in the image.

2

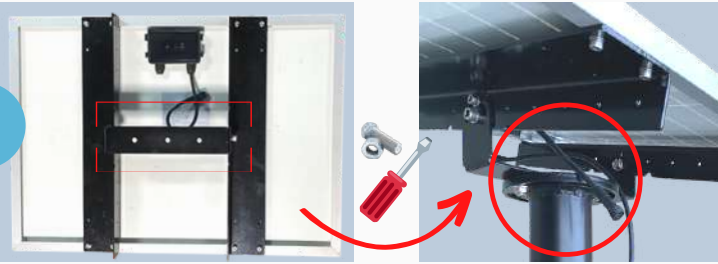

Step 2: The solar panel is fixed to the panel mounting apparatus at the top of the pole with stainless screws, as seen in the technical picture.

The panel should be adjusted in the south direction and turned at an angle of 40°.

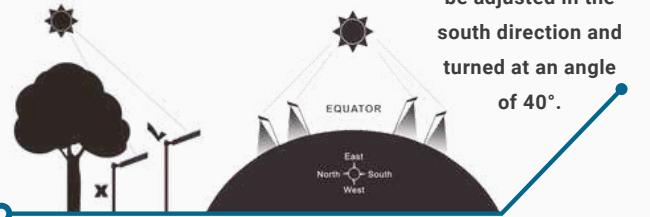

3

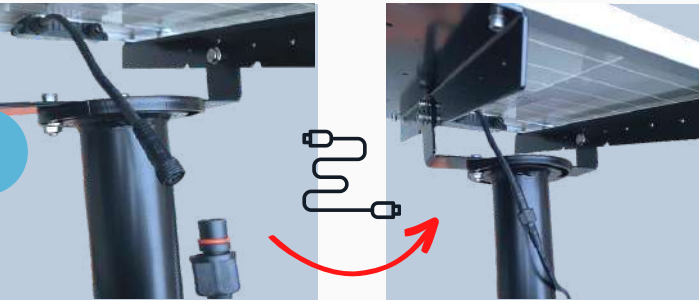

Step 3: The solar panel and the special solar cables connected to the solar LED luminaire must be correctly combined with each other. Please pay attention and be careful with the joining nails.

4



Step 4: Press the button on the solar led armature once, (during first installation only), and there will be no need to do the on-off operation This is how the installation is completed.

! The cover of the product is locked from the inside by Yakan Aydınlatma during production. If the product is opened outside of the manufacturer's authorities, the product will be out of warranty.

Recommendation: In terms of panel efficiency, it is recommended to clean the panel at certain intervals. The frequency of cleaning may vary depending on the area used. (eg. areas with dusty, polluted air)

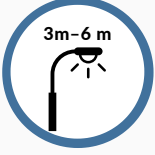

Y.A.127040

SOLAR AYDINLATMA ÖZELLİKLERİ / SPECIFICATIONS OF SOLAR LIGHTING

Ürün Kodu Product Code	Y.A-127040	Tam-Sürekli Çalışma Süresi Working Time Full-Continuous	12 Saat (Ortalama) 12 Hours (Average)
Muadil Enerji Equivalent Power	100W-150W	Sensörlü Çalışma Süresi Working Time with Sensor	20-22 Saat (Ortalama) 20-22 Hours (Average)
Uyumlu Lensler Suitable Lenses	Yüksek Verimli Özel Solar 90°Lens High Efficiency Special Solar 90°Lens	Çalışma Ortamı Sıcaklık Koşulları Working conditions according to temperature	-20°C ~ +65°C
Solar Panel	60W Monocrystalline	Toplam Ağırlığı Total Weight	19.3 KG
Batarya Battery	LiFePO4 En Az 5 Yıl Ömür Beklentili Batarya, aşırı şarj ve aşırı deşarj durumlarına karşı akım dengeleyici BMS devresi ile korunmaktadır. LiFePO4 5 Years Minimum Life Expectancy The current balanced BMS circuit guards the battery from overcharging and over discharging.	Armatür Luminaire	IP66 Alüminyum gövdelidir. Ürün Ø7,6 cm'lik boruya uygundur. The product has an IP66 aluminum body. The product is designed to fit Ø7.6 cm pole.
Yaklaşık Lümen Average Lumen	3100-5200 Lumen	Led Verimliliği Led Efficiency	170-220 Lm/W
Önerilen Kullanım Yüksekliği Suggested Height	3m – 6m	Renk Sıcaklığı Color Temperature	6500K Yüksek Verimli High Efficiency
Yeterli Aydınlık Alanı / Average Area for Lighting	100 m ²	Led Markası ve Ömrü Brand and LifeTime of Led	Nichia / Samsung Japon Menşei Made in Japan 60.000 Saat / Hours
Güneş Altında Şarj Olma Süresi Charging Time Under Sun	6-8 Saat (Ortalama) 6-8 Hours (Average)	Ortalama Işık Seviyesi Average Lighting Level	15-25 lux

Ürünümüzde paslanmaz civata kullanılmıştır / Stainless bolts are used in product.

Garanti / Warranty : 2 Yıl (Year)

Not: Hesaplar ortalama değerler alınarak hesaplanmıştır. / Note: Calculations had been made over average values.

Ürün ölçülerinde +,- %10'a kadar tolerans olabilir / There may be a tolerance of +,-%10 in products dimensions.

KULLANIM YERLERİ/PLACES OF USE



Otoparklar
Car Parkings



Konutlar, Binalar
Residential and
Builds



Yollar
Road



Yürüyüş Yolları
Walking Trails

İŞIK DAĞILIMI LIGHT DISTRIBUTION 90x90

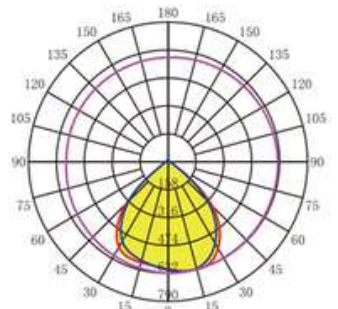

ADVANTAGES OF USING SOLAR LIGHTING



- There will be no carbon emissions.
- Eliminating Expensive Cabling and Electricity Costs
- Easy setup,
- Opportunity for Part Exchange,
- IP66 Waterproof,
- Polycarbonate (PC) or PMMA High Efficiency Lenses



IP66

Uyarılar

Bataryalara zarar verebilen herhangi taşıma veya saklama şekli tehlikeli ve yasaktır. Bataryalar pil atık kutusuna atılmalıdır.



Cautions

Obtaining batteries with any effect that may cause damage during transport or storage processes is strictly prohibited. Batteries should be disposed of in the battery waste bin.

1964'den bugüne..

YAKAN AYDINLATMA®

Dış Mekan Dekoratif Aydınlatma Mamülleri İmalat ve Ticaret
Best Globe®

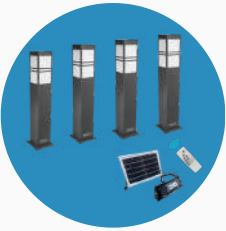
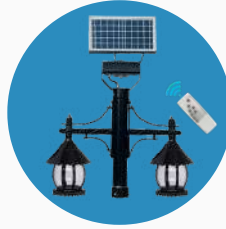
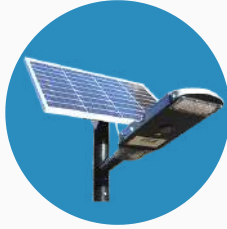

1964'den bugüne..

YAKAN AYDINLATMA®

Dış Mekan Dekoratif Aydınlatma Mamülleri İmalat ve Ticaret
Best Globe®

İkitelli O.S.B. Tormak Sanayi Sitesi C Blok No 2 Basaksehir İstanbul
Türkiye

Showroom Tel (pbx) : +90 212 243 30 08

Factory Tel (pbx) : +90 212 485 13 43

Whatsapp : +90 535 015 90 10

www.yakanaydinlatma.com / info@yakanaydinlatma.com.tr